

# **PHILIPPINE BIDDING DOCUMENTS**

(As Harmonized with Development Partners)

## **Procurement of INFRASTRUCTURE PROJECTS for the Fabrication and Installation of Signages in the JHSEZ**

Government of the Republic of the Philippines

**Sixth Edition**

**July 2020**

# TABLE OF CONTENTS

<b>Glossary of Terms, Abbreviations, and Acronyms.....</b>	<b>4</b>
<b>Section I. Invitation to Bid .....</b>	<b>7</b>
<b>Section II. Instructions to Bidders.....</b>	<b>11</b>
1. Scope of Bid.....	12
2. Funding Information .....	12
3. Bidding Requirements.....	12
4. Corrupt, Fraudulent, Collusive, Coercive, and Obstructive Practices .....	13
5. Eligible Bidders.....	13
6. Origin of Associated Goods .....	13
7. Subcontracts .....	13
8. Pre-Bid Conference.....	14
9. Clarification and Amendment of Bidding Documents.....	14
10. Documents Comprising the Bid: Eligibility and Technical Components.....	14
11. Documents Comprising the Bid: Financial Component .....	15
12. Alternative Bids .....	15
13. Bid Prices .....	16
14. Bid and Payment Currencies.....	16
15. Bid Security.....	16
16. Sealing and Marking of Bids.....	16
17. Deadline for Submission of Bids .....	17
18. Opening and Preliminary Examination of Bids .....	17
19. Detailed Evaluation and Comparison of Bids .....	17
20. Post Qualification.....	17
21. Signing of the Contract .....	18
<b>Section III. Bid Data Sheet.....</b>	<b>19</b>
<b>Section IV. General Conditions of Contract .....</b>	<b>22</b>
1. Scope of Contract.....	23
2. Sectional Completion of Works .....	23
3. Possession of Site.....	23
4. The Contractor’s Obligations .....	23
5. Performance Security .....	24

6.	Site Investigation Reports .....	24
7.	Warranty.....	24
8.	Liability of the Contractor.....	24
9.	Termination for Other Causes .....	24
10.	Dayworks .....	25
11.	Program of Work.....	25
12.	Instructions, Inspections and Audits .....	25
13.	Advance Payment.....	25
14.	Progress Payments .....	25
15.	Operating and Maintenance Manuals.....	26
<b>Section V. Special Conditions of Contract.....</b>		<b>27</b>
<b>Section VI. Specifications .....</b>		<b>29</b>
<b>Section VII. Drawings.....</b>		<b>34</b>
<b>Section VIII. Bill of Quantities .....</b>		<b>34</b>
<b>Section IX. Checklist of Technical and Financial Documents.....</b>		<b>45</b>

# *Glossary of Terms, Abbreviations, and Acronyms*

**ABC** – Approved Budget for the Contract.

**ARCC** – Allowable Range of Contract Cost.

**BAC** – Bids and Awards Committee.

**Bid** – A signed offer or proposal to undertake a contract submitted by a bidder in response to and in consonance with the requirements of the bidding documents. Also referred to as *Proposal* and *Tender*. (2016 revised IRR, Section 5[c])

**Bidder** – Refers to a contractor, manufacturer, supplier, distributor and/or consultant who submits a bid in response to the requirements of the Bidding Documents. (2016 revised IRR, Section 5[d])

**Bidding Documents** – The documents issued by the Procuring Entity as the bases for bids, furnishing all information necessary for a prospective bidder to prepare a bid for the Goods, Infrastructure Projects, and/or Consulting Services required by the Procuring Entity. (2016 revised IRR, Section 5[e])

**BIR** – Bureau of Internal Revenue.

**BSP** – Bangko Sentral ng Pilipinas.

**CDA** – Cooperative Development Authority.

**Consulting Services** – Refer to services for Infrastructure Projects and other types of projects or activities of the GOP requiring adequate external technical and professional expertise that are beyond the capability and/or capacity of the GOP to undertake such as, but not limited to: (i) advisory and review services; (ii) pre-investment or feasibility studies; (iii) design; (iv) construction supervision; (v) management and related services; and (vi) other technical services or special studies. (2016 revised IRR, Section 5[i])

**Contract** – Refers to the agreement entered into between the Procuring Entity and the Supplier or Manufacturer or Distributor or Service Provider for procurement of Goods and Services; Contractor for Procurement of Infrastructure Projects; or Consultant or Consulting Firm for Procurement of Consulting Services; as the case may be, as recorded in the Contract Form signed by the parties, including all attachments and appendices thereto and all documents incorporated by reference therein.

**Contractor** – is a natural or juridical entity whose proposal was accepted by the Procuring Entity and to whom the Contract to execute the Work was awarded. Contractor as used in these Bidding Documents may likewise refer to a supplier, distributor, manufacturer, or consultant.

**CPI** – Consumer Price Index.

**DOLE** – Department of Labor and Employment.

**DTI** – Department of Trade and Industry.

**Foreign-funded Procurement or Foreign-Assisted Project** – Refers to procurement whose funding source is from a foreign government, foreign or international financing institution as specified in the Treaty or International or Executive Agreement. (2016 revised IRR, Section 5[b]).

**GFI** – Government Financial Institution.

**GOCC** – Government-owned and/or –controlled corporation.

**Goods** – Refer to all items, supplies, materials and general support services, except Consulting Services and Infrastructure Projects, which may be needed in the transaction of public businesses or in the pursuit of any government undertaking, project or activity, whether in the nature of equipment, furniture, stationery, materials for construction, or personal property of any kind, including non-personal or contractual services such as the repair and maintenance of equipment and furniture, as well as trucking, hauling, janitorial, security, and related or analogous services, as well as procurement of materials and supplies provided by the Procuring Entity for such services. The term “related” or “analogous services” shall include, but is not limited to, lease or purchase of office space, media advertisements, health maintenance services, and other services essential to the operation of the Procuring Entity. (2016 revised IRR, Section 5[r])

**GOP** – Government of the Philippines.

**Infrastructure Projects** – Include the construction, improvement, rehabilitation, demolition, repair, restoration or maintenance of roads and bridges, railways, airports, seaports, communication facilities, civil works components of information technology projects, irrigation, flood control and drainage, water supply, sanitation, sewerage and solid waste management systems, shore protection, energy/power and electrification facilities, national buildings, school buildings, hospital buildings, and other related construction projects of the government. Also referred to as *civil works or works*. (2016 revised IRR, Section 5[u])

**LGUs** – Local Government Units.

**NFCC** – Net Financial Contracting Capacity.

**NGA** – National Government Agency.

**PCAB** – Philippine Contractors Accreditation Board.

**PhilGEPS** - Philippine Government Electronic Procurement System.

**Procurement Project** – refers to a specific or identified procurement covering goods, infrastructure project or consulting services. A Procurement Project shall be described, detailed, and scheduled in the Project Procurement Management Plan prepared by the agency which shall be consolidated in the procuring entity's Annual Procurement Plan. (GPPB Circular No. 06-2019 dated 17 July 2019)

**PSA** – Philippine Statistics Authority.

**SEC** – Securities and Exchange Commission.

**SLCC** – Single Largest Completed Contract.

**UN** – United Nations.

## ***Section I. Invitation to Bid***

## Invitation to Bid for Fabrication and Installation of Signages in the JHSEZ

1. The John Hay Management Corporation (JHMC), through the Corporate Operating Budget for CY 2023 intends to apply the sum of One Million Five Hundred Thousand Pesos (PhP 1,500,000.00) being the Approved Budget for the Contract (ABC) to payments under the contract for the **Fabrication and Installation of Signages in the JHSEZ, Infra-2**. Bids received in excess of the ABC shall be automatically rejected at bid opening.
2. The JHMC now invites bids for the above Procurement Project. Completion of the Works required is **Seventy Five (75)** Calendar Days. Bidders should have completed a contract similar to the Project. The description of an eligible bidder is contained in the Bidding Documents, particularly, in Section II (Instructions to Bidders).
3. Bidding will be conducted through open competitive bidding procedures using non-discretionary “pass/fail” criterion as specified in the 2016 revised Implementing Rules and Regulations (IRR) of Republic Act (RA) No. 9184.

JHMC allows the participation of prospective bidders through personal appearance or video conferencing. Bidders may submit their bids using the two (2) separate sealed bid envelopes system or **two (2) password-protected Bidding Documents in compressed archive folders, in case of electronic bid submission**, and which shall be submitted simultaneously. The first shall contain the technical component of the bid, including the eligibility requirements, and the second shall contain the financial component of the bid.

4. Interested bidders may obtain further information from JHMC Office, JHSEZ and inspect the Bidding Documents from 03 August 2023 to 16 August 2023 9:00 A.M to 4:00 P.M., Mondays to Fridays.
5. A complete set of Bidding Documents may be acquired by interested bidders on 08 August 2023 from JHMC Office, JHSEZ and website/s below and upon payment of the applicable fee for Bidding Documents, pursuant to the latest Guidelines issued by the GPPB, in the amount of Php 5,000.00. The Procuring Entity shall allow the bidder to present its proof of payment for the fees and may be presented in person or through electronic means.

Interested bidders may personally pay for Bidding Documents at the Finance Department, JHMC Office Building, JHSEZ, Baguio City.



Payment may also be done via electronic fund transfer or direct bank deposit using the following deposit details:

Payee Name: John Hay Management Corporation  
Depository Bank: Development Bank of the Philippines Session Road, Baguio City  
Branch Account Number: 0510-004308-031

6. The JHMC will hold a Pre-Bid Conference<sup>1</sup> at 11:00 AM on 16 August 2023 at the Board Room, JHMC Office Building, JHSEZ, Baguio City and/ or through videoconferencing/ webcasting.

The Pre-bid conference will be conducted in person or face-to-face through video conferencing. Prospective Bidders who opt for video conferencing must inform the BAC Secretariat of their intent through the electronic mail address listed below. The Pre-Bid Conference is open to prospective bidders but attendance shall not be mandatory.

7. Bids must be duly received by the BAC Secretariat through manual submission at the JHMC Office, JHSEZ, Baguio City, on or before 9:30 A.M. on 31 August 2023. Late bids shall not be accepted.
8. All bids must be accompanied by a bid security in any of the acceptable forms and in the amount stated in **ITB** Clause 16.
9. Bid opening shall be at 11:00 AM on 31 August 2023 at the Board Room, JHMC Office Building, JHSEZ, Baguio City and/or through video conferencing. Bids will be opened in the presence of the bidders' representatives who choose to attend the activity.
10. The JHMC reserves the right to reject any and all bids, declare a failure of bidding, or not award the contract at any time prior to contract award in accordance with Sections 35.6 and 41 of the 2016 revised Implementing Rules and Regulations (IRR) of RA No. 9184, without thereby incurring any liability to the affected bidder or bidders.
11. For further information, please refer to:

DARWIN C. PEREZ  
Head, BAC Secretariat  
John Hay Management Corporation  
JHMC Office, Camp John Hay, Baguio City  
Telephone Number (074) 422-4360  
E-mail: [bac@jhmc.com.ph](mailto:bac@jhmc.com.ph)

---

<sup>1</sup> May be deleted in case the ABC is less than One Million Pesos (PhP1,000,000) where the Procuring Entity may not hold a pre-bid conference.

12. You may visit the following websites:

For downloading of Bidding Documents: [www.jhmc.com.ph](http://www.jhmc.com.ph)

**(SGD.) JANE THERESA G. TABALINGCOS**  
BAC Chairperson

## *Section II. Instructions to Bidders*

## 1. Scope of Bid

The Procuring Entity, John Hay Management Corporation invites Bids for the **Fabrication and Installation of Signages in the JHSEZ.**

The Procurement Project (referred to herein as “Project”) is for the construction of Works, as described in Section VI (Specifications).

## 2. Funding Information

2.1. The GOP through the source of funding as indicated below for Corporate Operating Budget for CY 2022 in the amount of Five Million Five Hundred Thousand Pesos (PhP 1,500,000.00)

2.2. The source of funding is:

JHMC Corporate Operating Budget 2023.

## 3. Bidding Requirements

The Bidding for the Project shall be governed by all the provisions of RA No. 9184 and its 2016 revised IRR, including its Generic Procurement Manual and associated policies, rules and regulations as the primary source thereof, while the herein clauses shall serve as the secondary source thereof.

Any amendments made to the IRR and other GPPB issuances shall be applicable only to the ongoing posting, advertisement, or invitation to bid by the BAC through the issuance of a supplemental or bid bulletin.

The Bidder, by the act of submitting its Bid, shall be deemed to have inspected the site, determined the general characteristics of the contracted Works and the conditions for this Project, such as the location and the nature of the work; (b) climatic conditions; (c) transportation facilities; (c) nature and condition of the terrain, geological conditions at the site communication facilities, requirements, location and availability of construction aggregates and other materials, labor, water, electric power and access roads; and (d) other factors that may affect the cost, duration and execution or implementation of the contract, project, or work and examine all instructions, forms, terms, and project requirements in the Bidding Documents.

#### **4. Corrupt, Fraudulent, Collusive, Coercive, and Obstructive Practices**

The Procuring Entity, as well as the Bidders and Contractors, shall observe the highest standard of ethics during the procurement and execution of the contract. They or through an agent shall not engage in corrupt, fraudulent, collusive, coercive, and obstructive practices defined under Annex “I” of the 2016 revised IRR of RA No. 9184 or other integrity violations in competing for the Project.

#### **5. Eligible Bidders**

- 5.1. Only Bids of Bidders found to be legally, technically, and financially capable will be evaluated.
- 5.2. The Bidder must have an experience of having completed a Single Largest Completed Contract (SLCC) that is similar to this Project, equivalent to at least fifty percent (50%) of the ABC adjusted, if necessary, by the Bidder to current prices using the PSA’s CPI, except under conditions provided for in Section 23.4.2.4 of the 2016 revised IRR of RA No. 9184.

A contract is considered to be “similar” to the contract to be bid if it has the major categories of work stated in the **BDS**.

- 5.3. For Foreign-funded Procurement, the Procuring Entity and the foreign government/foreign or international financing institution may agree on another track record requirement, as specified in the Bidding Document prepared for this purpose.
- 5.4. The Bidders shall comply with the eligibility criteria under Section 23.4.2 of the 2016 IRR of RA No. 9184.

#### **6. Origin of Associated Goods**

There is no restriction on the origin of Goods other than those prohibited by a decision of the UN Security Council taken under Chapter VII of the Charter of the UN.

#### **7. Subcontracts**

- 7.1. The Bidder may subcontract portions of the Project to the extent allowed by the Procuring Entity as stated herein, but in no case more than fifty percent (50%) of the Project.

The Procuring Entity has prescribed that:

- a. Subcontracting is not allowed.

- 7.1. The Bidder must submit together with its Bid the documentary requirements of the subcontractor(s) complying with the eligibility criterion stated in **ITB** Clause 5 in accordance with Section 23.4 of the 2016 revised IRR of RA No. 9184 pursuant to Section 23.1 thereof.
- 7.2. The Supplier may identify its subcontractor during the contract implementation stage. Subcontractors identified during the bidding may be changed during the implementation of this Contract. Subcontractors must submit the documentary requirements under Section 23.1 of the 2016 revised IRR of RA No. 9184 and comply with the eligibility criteria specified in **ITB** Clause 5 to the implementing or end-user unit.
- 7.3. Subcontracting of any portion of the Project does not relieve the Contractor of any liability or obligation under the Contract. The Supplier will be responsible for the acts, defaults, and negligence of any subcontractor, its agents, servants, or workmen as fully as if these were the Contractor's own acts, defaults, or negligence, or those of its agents, servants, or workmen.

## **8. Pre-Bid Conference**

The Procuring Entity will hold a pre-bid conference for this Project on the specified date and time and either at its physical address JHMC Conference Room, Sheridan Drive, Camp John Hay, Baguio City and/or through videoconferencing/webcasting as indicated in paragraph 6 of the **IB**.

## **9. Clarification and Amendment of Bidding Documents**

Prospective bidders may request for clarification on and/or interpretation of any part of the Bidding Documents. Such requests must be in writing and received by the Procuring Entity, either at its given address or through electronic mail indicated in the **IB**, at least ten (10) calendar days before the deadline set for the submission and receipt of Bids.

## **10. Documents Comprising the Bid: Eligibility and Technical Components**

- 10.1. The first envelope shall contain the eligibility and technical documents of the Bid as specified in **Section IX. Checklist of Technical and Financial Documents**.
- 10.2. If the eligibility requirements or statements, the bids, and all other documents for submission to the BAC are in foreign language other than English, it must be accompanied by a translation in English, which shall be authenticated by the

appropriate Philippine foreign service establishment, post, or the equivalent office having jurisdiction over the foreign bidder's affairs in the Philippines. For Contracting Parties to the Apostille Convention, only the translated documents shall be authenticated through an apostille pursuant to GPPB Resolution No. 13-2019 dated 23 May 2019. The English translation shall govern, for purposes of interpretation of the bid.

- 10.3. A valid PCAB License is required, and in case of joint ventures, a valid special PCAB License, and registration for the type and cost of the contract for this Project. Any additional type of Contractor license or permit shall be indicated in the **BDS**.
- 10.4. A List of Contractor's key personnel (e.g., Project Manager, Project Engineers, Materials Engineers, and Foremen) assigned to the contract to be bid, with their complete qualification and experience data shall be provided. These key personnel must meet the required minimum years of experience set in the **BDS**.
- 10.5. A List of Contractor's major equipment units, which are owned, leased, and/or under purchase agreements, supported by proof of ownership, certification of availability of equipment from the equipment lessor/vendor for the duration of the project, as the case may be, must meet the minimum requirements for the contract set in the **BDS**.

## **11. Documents Comprising the Bid: Financial Component**

- 11.1. The second bid envelope shall contain the financial documents for the Bid as specified in **Section IX. Checklist of Technical and Financial Documents**.
- 11.2. Any bid exceeding the ABC indicated in paragraph 1 of the **IB** shall not be accepted.
- 11.3. For Foreign-funded procurement, a ceiling may be applied to bid prices provided the conditions are met under Section 31.2 of the 2016 revised IRR of RA No. 9184.

## **12. Alternative Bids**

Bidders shall submit offers that comply with the requirements of the Bidding Documents, including the basic technical design as indicated in the drawings and specifications. Unless there is a value engineering clause in the **BDS**, alternative Bids shall not be accepted.

### 13. Bid Prices

All bid prices for the given scope of work in the Project as awarded shall be considered as fixed prices, and therefore not subject to price escalation during contract implementation, except under extraordinary circumstances as determined by the NEDA and approved by the GPPB pursuant to the revised Guidelines for Contract Price Escalation guidelines.

### 14. Bid and Payment Currencies

14.1. Bid prices may be quoted in the local currency or tradeable currency accepted by the BSP at the discretion of the Bidder. However, for purposes of bid evaluation, Bids denominated in foreign currencies shall be converted to Philippine currency based on the exchange rate as published in the BSP reference rate bulletin on the day of the bid opening.

14.2. *Payment of the contract price shall be made in:*

- a. Philippine Pesos.

### 15. Bid Security

15.1. The Bidder shall submit a Bid Securing Declaration or any form of Bid Security in the amount indicated in the **BDS**, which shall be not less than the percentage of the ABC in accordance with the schedule in the **BDS**.

15.2. The Bid and bid security shall be valid until One Hundred Twenty Days. Any bid not accompanied by an acceptable bid security shall be rejected by the Procuring Entity as non-responsive.

### 16. Sealing and Marking of Bids

Each Bidder shall submit one copy of the first and second components of its Bid.

The Procuring Entity may request additional hard copies and/or electronic copies of the Bid. However, failure of the Bidders to comply with the said request shall not be a ground for disqualification.

If the Procuring Entity allows the submission of bids through online submission to the given website or any other electronic means, the Bidder shall submit an electronic copy of its Bid, which must be digitally signed. An electronic copy that cannot be opened or is corrupted shall be considered non-responsive and, thus, automatically disqualified.



## 17. Deadline for Submission of Bids

The Bidders shall submit on the specified date and time and either at its physical address or through online submission as indicated in paragraph 7 of the **IB**.

## 18. Opening and Preliminary Examination of Bids

18.1. The BAC shall open the Bids in public at the time, on the date, and at the place specified in paragraph 9 of the **IB**. The Bidders' representatives who are present shall sign a register evidencing their attendance. In case videoconferencing, webcasting or other similar technologies will be used, attendance of participants shall likewise be recorded by the BAC Secretariat.

In case the Bids cannot be opened as scheduled due to justifiable reasons, the rescheduling requirements under Section 29 of the 2016 revised IRR of RA No. 9184 shall prevail.

18.2. The preliminary examination of Bids shall be governed by Section 30 of the 2016 revised IRR of RA No. 9184.

## 19. Detailed Evaluation and Comparison of Bids

19.1. The Procuring Entity's BAC shall immediately conduct a detailed evaluation of all Bids rated "*passed*" using non-discretionary pass/fail criteria. The BAC shall consider the conditions in the evaluation of Bids under Section 32.2 of 2016 revised IRR of RA No. 9184.

19.2. If the Project allows partial bids, all Bids and combinations of Bids as indicated in the **BDS** shall be received by the same deadline and opened and evaluated simultaneously so as to determine the Bid or combination of Bids offering the lowest calculated cost to the Procuring Entity. Bid Security as required by **ITB** Clause 16 shall be submitted for each contract (lot) separately.

19.3. In all cases, the NFCC computation pursuant to Section 23.4.2.6 of the 2016 revised IRR of RA No. 9184 must be sufficient for the total of the ABCs for all the lots participated in by the prospective Bidder.

## 20. Post Qualification

Within a non-extendible period of five (5) calendar days from receipt by the Bidder of the notice from the BAC that it submitted the Lowest Calculated Bid, the Bidder shall submit its latest income and business tax returns filed and paid through the BIR

Electronic Filing and Payment System (eFPS), and other appropriate licenses and permits required by law and stated in the **BDS**.

## **21. Signing of the Contract**

The documents required in Section 37.2 of the 2016 revised IRR of RA No. 9184 shall form part of the Contract. Additional Contract documents are indicated in the **BDS**.

## ***Section III. Bid Data Sheet***

# Bid Data Sheet

ITB Clause																																					
5.2	For this purpose, contracts similar to the Project refer to contracts which have the same major categories of work, which shall be: Fabrication of Signages																																				
7.1	Sub-contracting is not allowed.																																				
10.3	No further instructions.																																				
10.4	<p>The key personnel must meet the required minimum years of experience set below:</p> <table border="1" style="width: 100%; border-collapse: collapse; margin-left: 20px;"> <thead> <tr> <th style="text-align: center;"><u>Key Personnel</u></th> <th style="text-align: center;"><u>General Experience</u></th> <th style="text-align: center;"><u>Relevant Experience</u></th> </tr> </thead> <tbody> <tr> <td style="text-align: center;">Project Engineer</td> <td style="text-align: center;">Five (5) Years</td> <td style="text-align: center;">General Construction and Engineering</td> </tr> <tr> <td style="text-align: center;">Materials Engineer</td> <td style="text-align: center;">Five (5) Years</td> <td style="text-align: center;">General Construction and Engineering</td> </tr> <tr> <td style="text-align: center;">Construction Safety and Health Officer</td> <td style="text-align: center;">Five (5) Years</td> <td style="text-align: center;">General Construction and Engineering</td> </tr> <tr> <td style="text-align: center;">Foreman</td> <td style="text-align: center;">Five (5) Years</td> <td style="text-align: center;">General Construction and Engineering</td> </tr> </tbody> </table>	<u>Key Personnel</u>	<u>General Experience</u>	<u>Relevant Experience</u>	Project Engineer	Five (5) Years	General Construction and Engineering	Materials Engineer	Five (5) Years	General Construction and Engineering	Construction Safety and Health Officer	Five (5) Years	General Construction and Engineering	Foreman	Five (5) Years	General Construction and Engineering																					
<u>Key Personnel</u>	<u>General Experience</u>	<u>Relevant Experience</u>																																			
Project Engineer	Five (5) Years	General Construction and Engineering																																			
Materials Engineer	Five (5) Years	General Construction and Engineering																																			
Construction Safety and Health Officer	Five (5) Years	General Construction and Engineering																																			
Foreman	Five (5) Years	General Construction and Engineering																																			
10.5	<p>The minimum major equipment requirements are the following:</p> <table border="1" style="width: 100%; border-collapse: collapse; margin-left: 20px;"> <thead> <tr> <th style="text-align: center;"><u>Equipment</u></th> <th style="text-align: center;"><u>Capacity</u></th> <th style="text-align: center;"><u>Number of Unit(s)</u></th> </tr> </thead> <tbody> <tr> <td style="text-align: center;">Service Vehicle</td> <td></td> <td></td> </tr> <tr> <td style="text-align: center;">Dump Truck</td> <td style="text-align: center;">12 cu. yd</td> <td style="text-align: center;">One (1)</td> </tr> <tr> <td style="text-align: center;">Backhoe</td> <td style="text-align: center;">0.80 cu mt.</td> <td style="text-align: center;">One (1)</td> </tr> <tr> <td style="text-align: center;">Vibratory Roller</td> <td style="text-align: center;">10 m.t. , SD100DC</td> <td style="text-align: center;">One (1)</td> </tr> <tr> <td style="text-align: center;">Welding Machine</td> <td></td> <td style="text-align: center;">One (1)</td> </tr> <tr> <td style="text-align: center;">Speed Cutter</td> <td></td> <td style="text-align: center;">One (1)</td> </tr> <tr> <td style="text-align: center;">Generator Set</td> <td></td> <td style="text-align: center;">One (1)</td> </tr> <tr> <td style="text-align: center;">Bar Bender</td> <td></td> <td style="text-align: center;">One (1)</td> </tr> <tr> <td style="text-align: center;">One-Bagger Mixer</td> <td style="text-align: center;">4-6 ft<sup>3</sup>/min</td> <td style="text-align: center;">One (1)</td> </tr> <tr> <td style="text-align: center;">Cargo Truck</td> <td style="text-align: center;">9-10 mt</td> <td style="text-align: center;">One (1)</td> </tr> <tr> <td style="text-align: center;">Plate Compactor</td> <td style="text-align: center;">5 hp</td> <td style="text-align: center;">One (1)</td> </tr> </tbody> </table>	<u>Equipment</u>	<u>Capacity</u>	<u>Number of Unit(s)</u>	Service Vehicle			Dump Truck	12 cu. yd	One (1)	Backhoe	0.80 cu mt.	One (1)	Vibratory Roller	10 m.t. , SD100DC	One (1)	Welding Machine		One (1)	Speed Cutter		One (1)	Generator Set		One (1)	Bar Bender		One (1)	One-Bagger Mixer	4-6 ft <sup>3</sup> /min	One (1)	Cargo Truck	9-10 mt	One (1)	Plate Compactor	5 hp	One (1)
<u>Equipment</u>	<u>Capacity</u>	<u>Number of Unit(s)</u>																																			
Service Vehicle																																					
Dump Truck	12 cu. yd	One (1)																																			
Backhoe	0.80 cu mt.	One (1)																																			
Vibratory Roller	10 m.t. , SD100DC	One (1)																																			
Welding Machine		One (1)																																			
Speed Cutter		One (1)																																			
Generator Set		One (1)																																			
Bar Bender		One (1)																																			
One-Bagger Mixer	4-6 ft <sup>3</sup> /min	One (1)																																			
Cargo Truck	9-10 mt	One (1)																																			
Plate Compactor	5 hp	One (1)																																			
12	No further instructions.																																				
15.1	<p>The bid security shall be in the form of a Bid Securing Declaration or any of the following forms and amounts:</p> <p style="margin-left: 20px;">a. The amount of not less than 2% of ABC or Thirty Thousand Pesos (PhP 30,000.00), if bid security is in cash, cashier's/manager's check, bank draft/guarantee or irrevocable letter of credit;</p>																																				

	b. The amount of not less than 5% of ABC or Seventy Five Thousand Pesos (PhP 75,000.00) if bid security is in Surety Bond.
19.2	Partial bid is not allowed. The infrastructure project is packaged in a single lot and the lot shall not be divided into sub-lots for the purpose of bidding, evaluation, and contract award.
20	Applicable JHMC Regulatory Permits/Licenses/Fees
21	Additional contract documents relevant to the Project that may be required by existing laws and/or the Procuring Entity, such as construction schedule and S-curve, manpower schedule, construction methods, equipment utilization schedule, construction safety and health program approved by the DOLE, JHMC Construction Environment Management Plan (CEMP) and other acceptable tools of project scheduling.

## ***Section IV. General Conditions of Contract***

## 1. Scope of Contract

This Contract shall include all such items, although not specifically mentioned, that can be reasonably inferred as being required for its completion as if such items were expressly mentioned herein. All the provisions of RA No. 9184 and its 2016 revised IRR, including the Generic Procurement Manual, and associated issuances, constitute the primary source for the terms and conditions of the Contract, and thus, applicable in contract implementation. Herein clauses shall serve as the secondary source for the terms and conditions of the Contract.

This is without prejudice to Sections 74.1 and 74.2 of the 2016 revised IRR of RA No. 9184 allowing the GPPB to amend the IRR, which shall be applied to all procurement activities, the advertisement, posting, or invitation of which were issued after the effectivity of the said amendment.

## 2. Sectional Completion of Works

If sectional completion is specified in the **Special Conditions of Contract (SCC)**, references in the Conditions of Contract to the Works, the Completion Date, and the Intended Completion Date shall apply to any Section of the Works (other than references to the Completion Date and Intended Completion Date for the whole of the Works).

## 3. Possession of Site

4.1. The Procuring Entity shall give possession of all or parts of the Site to the Contractor based on the schedule of delivery indicated in the **SCC**, which corresponds to the execution of the Works. If the Contractor suffers delay or incurs cost from failure on the part of the Procuring Entity to give possession in accordance with the terms of this clause, the Procuring Entity's Representative shall give the Contractor a Contract Time Extension and certify such sum as fair to cover the cost incurred, which sum shall be paid by Procuring Entity.

4.2. If possession of a portion is not given by the above date, the Procuring Entity will be deemed to have delayed the start of the relevant activities. The resulting adjustments in contract time to address such delay may be addressed through contract extension provided under Annex "E" of the 2016 revised IRR of RA No. 9184.

## 4. The Contractor's Obligations

The Contractor shall employ the key personnel named in the Schedule of Key Personnel indicating their designation, in accordance with **ITB** Clause 10.3 and specified in the **BDS**, to carry out the supervision of the Works.

The Procuring Entity will approve any proposed replacement of key personnel only if their relevant qualifications and abilities are equal to or better than those of the personnel listed in the Schedule.

## **5. Performance Security**

- 5.1. Within ten (10) calendar days from receipt of the Notice of Award from the Procuring Entity but in no case later than the signing of the contract by both parties, the successful Bidder shall furnish the performance security in any of the forms prescribed in Section 39 of the 2016 revised IRR.
- 5.2. The Contractor, by entering into the Contract with the Procuring Entity, acknowledges the right of the Procuring Entity to institute action pursuant to RA No. 3688 against any subcontractor be they an individual, firm, partnership, corporation, or association supplying the Contractor with labor, materials and/or equipment for the performance of this Contract.

## **6. Site Investigation Reports**

The Contractor, in preparing the Bid, shall rely on any Site Investigation Reports referred to in the SCC supplemented by any information obtained by the Contractor.

## **7. Warranty**

- 7.1. In case the Contractor fails to undertake the repair works under Section 62.2.2 of the 2016 revised IRR, the Procuring Entity shall forfeit its performance security, subject its property(ies) to attachment or garnishment proceedings, and perpetually disqualify it from participating in any public bidding. All payables of the GOP in his favor shall be offset to recover the costs.
- 7.2. The warranty against Structural Defects/Failures, except that occasioned-on force majeure, shall cover the period from the date of issuance of the Certificate of Final Acceptance by the Procuring Entity. Specific duration of the warranty is found in the SCC.

## **8. Liability of the Contractor**

Subject to additional provisions, if any, set forth in the SCC, the Contractor's liability under this Contract shall be as provided by the laws of the Republic of the Philippines.

If the Contractor is a joint venture, all partners to the joint venture shall be jointly and severally liable to the Procuring Entity.

## **9. Termination for Other Causes**

Contract termination shall be initiated in case it is determined *prima facie* by the Procuring Entity that the Contractor has engaged, before, or during the implementation of the contract, in unlawful deeds and behaviors relative to contract acquisition and implementation, such as, but not limited to corrupt, fraudulent, collusive, coercive, and obstructive practices as stated in **ITB** Clause 4.



## **10. Dayworks**

Subject to the guidelines on Variation Order in Annex “E” of the 2016 revised IRR of RA No. 9184, and if applicable as indicated in the **SCC**, the Dayworks rates in the Contractor’s Bid shall be used for small additional amounts of work only when the Procuring Entity’s Representative has given written instructions in advance for additional work to be paid for in that way.

## **11. Program of Work**

11.1. The Contractor shall submit to the Procuring Entity’s Representative for approval the said Program of Work showing the general methods, arrangements, order, and timing for all the activities in the Works. The submissions of the Program of Work are indicated in the **SCC**.

11.2. The Contractor shall submit to the Procuring Entity’s Representative for approval an updated Program of Work at intervals no longer than the period stated in the **SCC**. If the Contractor does not submit an updated Program of Work within this period, the Procuring Entity’s Representative may withhold the amount stated in the **SCC** from the next payment certificate and continue to withhold this amount until the next payment after the date on which the overdue Program of Work has been submitted.

## **12. Instructions, Inspections and Audits**

The Contractor shall permit the GOP or the Procuring Entity to inspect the Contractor’s accounts and records relating to the performance of the Contractor and to have them audited by auditors of the GOP or the Procuring Entity, as may be required.

## **13. Advance Payment**

The Procuring Entity shall, upon a written request of the Contractor which shall be submitted as a Contract document, make an advance payment to the Contractor in an amount not exceeding fifteen percent (15%) of the total contract price, to be made in lump sum, or at the most two installments according to a schedule specified in the **SCC**, subject to the requirements in Annex “E” of the 2016 revised IRR of RA No. 9184.

## **14. Progress Payments**

The Contractor may submit a request for payment for Work accomplished. Such requests for payment shall be verified and certified by the Procuring Entity’s Representative/Project Engineer. Except as otherwise stipulated in the **SCC**, materials and equipment delivered on the site but not completely put in place shall not be included for payment.

## **15. Operating and Maintenance Manuals**

- 15.1. If required, the Contractor will provide “as built” Drawings and/or operating and maintenance manuals as specified in the **SCC**.
- 15.2. If the Contractor does not provide the Drawings and/or manuals by the dates stated above, or they do not receive the Procuring Entity’s Representative’s approval, the Procuring Entity’s Representative may withhold the amount stated in the **SCC** from payments due to the Contractor.

## *Section V. Special Conditions of Contract*

## Special Conditions of Contract

GCC Clause	
2	Target date of completion is Seventy Five (75) Calendar Days upon the effectivity of the Notice to Proceed.
4.1	Upon issuance of Notice to Proceed.
6	The site investigation reports are: existing site conditions
10	Dayworks are applicable at the rate shown in the Contractor's original Bid.
11.1	The Contractor shall submit the Program of Work to the Procuring Entity's Representative within Five (5) Calendar days from delivery of the Notice of Award.
11.2	The amount to be withheld for late submission of an updated Program of Work is One Thousand Pesos (Php1,000.00)
13	The amount of the advance payment is fifteen (15) percent to be released within 30 days from receipt of letter and other requirements.
14	No further instructions.
15.1	The date by which "as built" drawings are required is upon request for progress and final billings.
15.2	The amount to be withheld for failing to produce "as built" drawings by the date required is One Thousand Pesos (Php1,000.00) per day of non-submission.

# ***Section VI. Specifications***

## **Fabrication and Installation of Signages in the JHSEZ**

### **1. GENERAL SPECIFICATIONS**

- 1.1 Construct informative and directional signages that aims improve and upgrade Camp John Hay as a tourist destination.
- 1.2 Impose required construction safety practices during the implementation of the project in compliance with the approved Occupational Safety and Health Program as required by the Department of Labor and Employment (DOLE).
- 1.3 Provide and maintain an accessible temporary field office/storage, portable toilets/latrines for workers. The Contractor shall be held responsible for the maintenance and protection of all facilities to be provided during the duration of the Contract.
- 1.4 Provide the necessary, required, and sufficient manpower, materials and equipment during the course of the project implementation.
- 1.5 Conduct the removal and proper disposal of structures and/or obstructions as indicated in the approved plans. All designated salvageable material shall be removed, without unnecessary damages, for safekeeping and turn-over to the end-user.
- 1.6 Properly and safely dispose all wastes generated during the construction phase, and ensure proper housekeeping, in conformance with the approved Construction Environmental Management Plan (CEMP).
- 1.7 Supervise or monitor the presence of the assigned Project Personnel (Project Engineer/Facilitator, Materials Engineer and / or Safety Officer) during project implementation.
- 1.8 Conduct site visits to familiarize with the on-site conditions and existing facilities.
- 1.9 Provide as-staked and as-built plans for the completed structure/s, one (1) set original CAD drawing in A3 size, two (2) additional copies, and electronic file of the following:
  - a. Actual layout and location of the structures constructed,
  - b. Details of the constructed structure, and,
  - c. All other details of the project that may be required.
- 1.10 Provide As-built plans which shall indicate the details specified in Section 1.9 in any scale not less than 1:100 meters.
- 1.11 Submit weekly Statement of Work Accomplishment reports during the duration of the Contract.
- 1.12 Shoulder all costs for power and water utilities to be used during the implementation of the project.
- 1.13 Shoulder and be responsible for all tests and engineering services required by the Specifications. The cost for inspection or test not required by the specifications but which are required by JHMC, will be borne by JHMC.
- 1.14 Ensure that all tests shall be performed by accredited testing facilities and approved by JHMC, and shall be in accordance with the current standards of the American Society for testing and materials, otherwise specified by JHMC. Two (2) copies of the test procedures including results shall be furnished to JHMC.
- 1.15 Report immediately to JHMC all unearthed hazardous materials, buried treasures or artifacts, and shall be coordinated by JHMC to the concerned agencies for their appropriate

- action. All activities in area of concern shall cease until such time that the hazardous materials, treasures have been properly dealt with.
- 1.16 Ensure that there will be no smoking, drinking of alcoholic beverages, spitting of momma, loitering among construction workers assigned in the construction premises.
  - 1.17 Perform regulated test/s to prove that all electricals/ electrically powered materials area working, as designed in its function.
  - 1.18 Ensure that all electronic products should pass all tests necessary to promote safety during the installation and operation of the signages requiring power/ lighting.
  - 1.19 Restore all damaged property during the project implementation to its original state.
  - 1.20 Shoulder all costs of permits necessary for the implementation of the project.
  - 1.21 Accomplish all total quantities per items of work with the assigned unit of measurement as stated in the approved program of work and plan.

## **2. STANDARD SPECIFICATIONS**

The scope of work shall be in conformity with of the DPWH standards and specifications stated herein.

### **B.5 - PROJECT BILLBOARD/ SIGNBOARD**

For the information and guidance of the citizenry about the on-going projects being undertaken by JHMC, a standard project billboard (JHMC and COA) shall be installed on the vicinity of the project using the standard design as shown in the Plan. Billboard should be sturdy and properly framed and installed in the most visible location within the vicinity of the project.

### **B.7(1) - OCCUPATIONAL SAFETY AND HEALTH PROGRAM**

This Item shall be in accordance with the provisions, systems and procedures based on the approved and applicable Occupational Safety and Health Program by the Department of Labor and Employment. Appropriate Personal Protective Equipment (PPE), including all safety devices that are necessary during project implementation, shall be provided by the contractor.

### **B.9. – MOBILIZATION/ DEMOBILIZATION**

Prior to mobilization of equipment and materials on site, the contractor shall coordinate with JHMC for the approved areas to be used for stockpiling of materials and parking of equipment on site. No construction materials or equipment should obstruct main access points within the vicinity of the project.

### **Item 102(2) - SURPLUS AND COMMON EXCAVATION**

All surface objects and all trees, stumps, roots and other protruding obstructions, not designated to remain, shall be cleared and/or grubbed, and disposed outside the clearing and grubbing limits as indicated.

All excavations shall be finished to reasonably smooth and uniform surfaces. No materials shall be wasted without authority of the contractor's Engineer and the JHMC Representative. Prior to excavation, all necessary clearing and grubbing in that area shall have been performed in accordance with Item Clearing and Grubbing.

All suitable materials removed from the excavation shall be used in the formation of the embankment, subgrade, shoulders, slopes, bedding, and backfill for structures, and for other purposes shown on the Plans or as directed. All unsuitable materials shall be disposed of as shown

on the Plans or as directed without delay by the Contractor. Only approved materials shall be used in the construction of embankments and backfills.

All excess materials, including rock and boulders that cannot be used in embankments shall be disposed of as directed.

#### **Item 104 – EMBANKMENT**

The item consists of embankment of excavated areas, or areas with lower elevation. Embankment material mostly comes from excavation/ from borrow. Proper compaction should be followed during the embankment process, with adequate compaction by plate compactor/ vibratory roller every 150mm thick layer of embankment material placed. This method should be carried out by the contractor until the proposed layer/ level is attained. No other materials should be mixed with the embankment.

#### **Item 605(3) – INFORMATIVE SIGNS**

All proposed signages may it be informative and/or directional should be properly fabricated, assembled, furnished, and have passed all testing activities before installation on identified strategic locations, as shown in the plan. All metal structures for the framing should be painted with primer, and free from rust.

Design should be approved by the implementing office, to assure that the same is fabricated as per approved plan and specifications. All letterings, directions, images, or other subjects in the signage should be well recognized and readable to serve its purpose.

Also, the signage should be constructed to last long, and with minimal maintenance during operation by being weather proof.

#### **Item 401(1) – METAL RAILINGS (SCHEDULE 40)**

Handrails/ metal railing to be constructed shall be 50mm diameter Galvanized Iron Pipes, Schedule 40, clean and rust-free. Concrete footing and dowel bars should be well prepared and poured according to plans and as stated. All steel pipes shall be accurately placed the position with proper spacing based on the approved plans.

Alignment of the handrails to be constructed should be straight and fully welded, furnished with paint after sanding or preparation of the connections to be even for the safety of the public. Railings shall be placed and then inspected and approved by the JHMC representative before the placing of concrete begins of finalization of the layout. Materials placed in violation of this provision may be rejected and removal may be required.

#### **Item 900(2) - STRUCTURAL CONCRETE**

Concrete shall consist of a mixture of Portland cement, fine aggregate, coarse aggregate, admixture when specified, and water mixed in the proportions specified or approved by the JHMC representative.

The class of concrete to be used is **Class A**. Only Type I Portland Cement shall be used unless otherwise provided for in the Special Provisions. Different brands or the same brands from different mills shall not be mixed nor shall they be used alternately unless the mix is approved by the Engineer.

Fine Aggregate shall consist of natural sand, stone screenings or other inert materials with similar characteristics, or combinations thereof, having hard, strong and durable particles.

Coarse Aggregate shall consist of crushed stone, gravel, blast furnace slag, or other approved inert materials (coralline or dolomites) of similar characteristics, or combinations thereof, having hard, strong, durable pieces and free from any adherent coatings. Water used in mixing, curing or other designated application shall be reasonably clean and free of oil, salt, acid, alkali, grass or other substances injurious to the finished product.

As work progresses, at least one (1) sample consisting of three (3) concrete cylinder test specimens, 150 x 300mm (6 x 12 inches), shall be taken from each seventy- five (75) cubic meters of each class of concrete or fraction thereof placed each day.

#### **Item 901 – LEAN CONCRETE**

As required, mostly for minor structures, lean concrete may be shown in the Plan or as directed by the Engineer prior to placing of reinforcing steel bar, the lean concrete should have a minimum compressive strength of 13.8 Mpa. This type of concrete should be used as protective cover of the proposed electrical wirings/ conduits from the proposed signages to the power supply.

#### **Item 902(1) - REINFORCING STEEL (GRADE 40)**

Steel reinforcements to be used shall be Grade 40 deformed steel bars, clean and rust-free. Minimum concrete cover for reinforcement is 50mm and 75mm for those exposed to soil/under earth. All steel reinforcements shall be accurately placed the position with proper spacing based on the approved plans.

Distance from the forms shall be maintained by means of stays, blocks, ties, hangers, or other approved supports. The use of pebbles, pieces of broken stone or brick, metal pipe and wooden blocks shall not be permitted. Reinforcement in any member shall be placed and then inspected and approved by the JHMC representative before the placing of concrete begins. Concrete placed in violation of this provision may be rejected and removal may be required.

#### **Item 1003(5) - STRUCTURAL STEEL**

The work will include the furnishing, fabricating, hauling, erecting, welding and painting of structural steel as shown on the Plans. Structural metals will include structural steel, rivet, welding, special and alloy steels, steel forgings and castings and iron castings. This work will also include any incidental metal construction not otherwise provided for, all in accordance with these Specifications, Plans and Special Provisions.

#### **Item 1046 – MASONRY – CONCRETE HOLLOW BLOCKS**

The work shall include in this scope of work the satisfactory performance of all work necessary to complete all cement and masonry works shown on the drawings and specified therein.

Cement mortar shall be one (1) part Portland Cement and two (2) parts sand by volume but no more than one (1) part Portland Cement and Three (3) parts sand and by volume.

Prior to installation, all concrete hollow blocks should be thoroughly wet before using. The first row of the blocks shall be properly anchored to the concrete base. Course shall be laid straight and well plumbed. Adequate rebars should be installed upon prosecution of the work.

#### **Item 1100(10), 1101(33), 1103(1) – ELECTRICALS**



This item shall consist of furnishing, and installation of high-quality conduits, boxes & fittings, wires and wiring devices, and lighting fixture and lamps, and all other related materials as specified in the plans

# Section VII. Drawings

## Fabrication and Installation of Signages in the JHSEZ

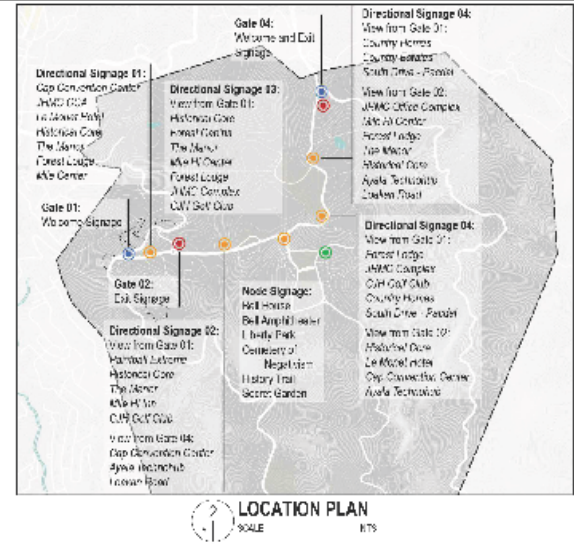
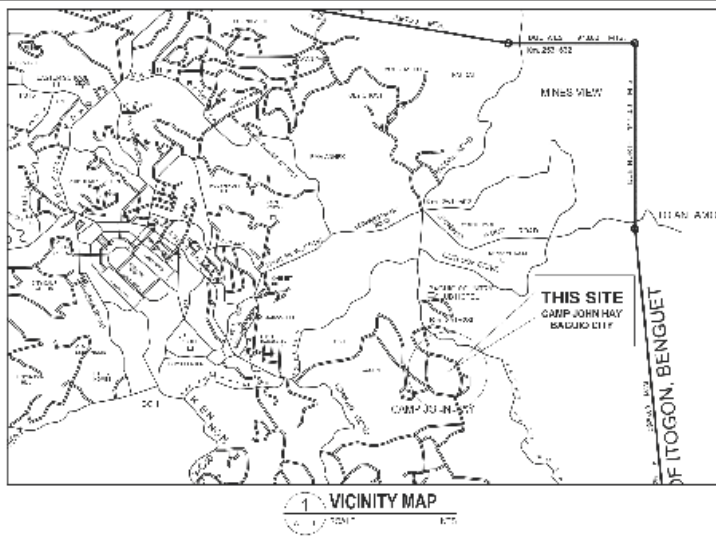

INDEX OF DRAWINGS	
1.1	VICINITY MAP
2.1	LOCATION PLAN
3.1	SUMMARY OF QUANTITIES
4.1	STANDARD COA PROJECT BILLBOARD DETAILS
4.2	STANDARD COA PROJECT BILLBOARD DETAILS
4.3	STANDARD COA PROJECT BILLBOARD DETAILS
4.4	STANDARD COA PROJECT BILLBOARD DETAILS
4.5	STANDARD COA PROJECT BILLBOARD DETAILS
4.6	STANDARD COA PROJECT BILLBOARD DETAILS
4.7	STANDARD COA PROJECT BILLBOARD DETAILS
4.8	STANDARD COA PROJECT BILLBOARD DETAILS
4.9	STANDARD COA PROJECT BILLBOARD DETAILS
4.10	STANDARD COA PROJECT BILLBOARD DETAILS

ITEM NO.	DESCRIPTION	QUANTITY	UNIT	REMARKS
1.1	PROJECT BILLBOARD SIGNBOARDS	1.00	EACH	Standard COA
2.1	OCCUPATIONAL SAFETY AND HEALTH	2.50	MONTHS	
3.1	NOISE POLLUTION MONITORING DEVICE	1.00	UNIT/HR	
100	STRUCTURE EXCAVATION	42.00	CUBIC METER	Concrete Soil
104	EMBANKMENT	37.00	CUBIC METER	From Quarry
201(04)	INFORMATIVE SIGN	1.00	EACH	For Gate
201(03)	INFORMATIVE SIGN	1.00	EACH	Historical & Park Sign
201(02)	INFORMATIVE SIGN	1.00	EACH	Water Damage
202(02)	INFORMATIVE SIGN	2.00	EACH	Directional Sign (Single Face)
202(03)	INFORMATIVE SIGN	3.00	EACH	Directional Sign (Double Face)
300(02)	STRUCTURAL CONCRETE	6.00	CUBIC METERS	24' Slabs
300(04)	LEAN CONCRETE	7.70	CUBIC METERS	
300(03)	REINFORCING STEEL	388.00	KILOGRAMS	Reinforcing Grade 40
100(04)	5. MIL. THICKNESS	1.00	LUMP SUM	
101(04)	5. MIL. THICKNESS	1.00	LUMP SUM	
102(04)	5. MIL. THICKNESS	1.00	LUMP SUM	
103(04)	5. MIL. THICKNESS	1.00	LUMP SUM	
104(04)	5. MIL. THICKNESS	1.00	LUMP SUM	
105(04)	5. MIL. THICKNESS	1.00	LUMP SUM	
106(04)	5. MIL. THICKNESS	1.00	LUMP SUM	
107(04)	5. MIL. THICKNESS	1.00	LUMP SUM	
108(04)	5. MIL. THICKNESS	1.00	LUMP SUM	
109(04)	5. MIL. THICKNESS	1.00	LUMP SUM	
110(04)	5. MIL. THICKNESS	1.00	LUMP SUM	
111(04)	5. MIL. THICKNESS	1.00	LUMP SUM	
112(04)	5. MIL. THICKNESS	1.00	LUMP SUM	
113(04)	5. MIL. THICKNESS	1.00	LUMP SUM	
114(04)	5. MIL. THICKNESS	1.00	LUMP SUM	
115(04)	5. MIL. THICKNESS	1.00	LUMP SUM	

**3 SUMMARY OF QUANTITIES**

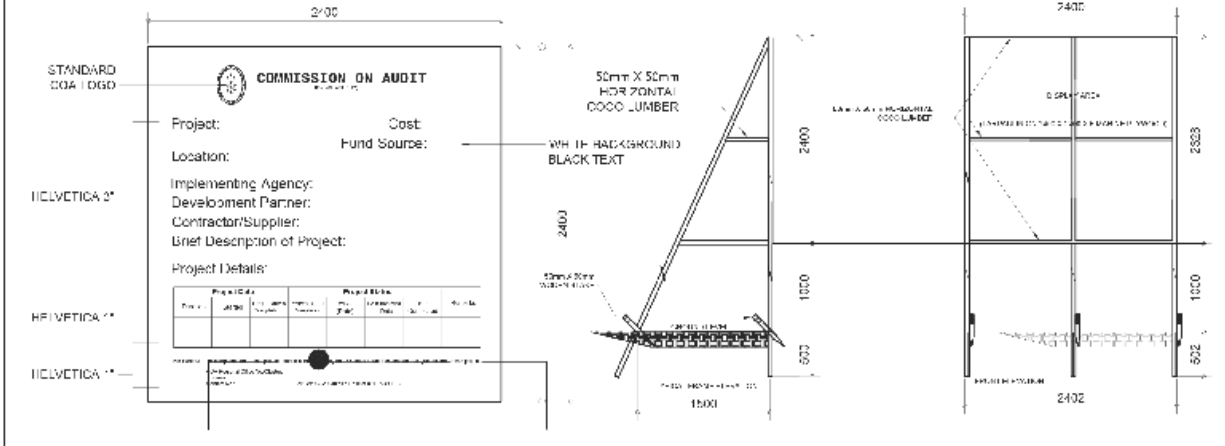



1 PERSPECTIVE  
1:200

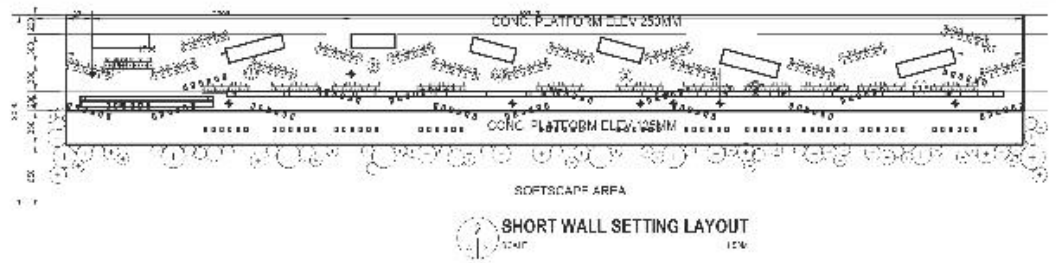

2 SHORT WALL SETTING LAYOUT  
1:200

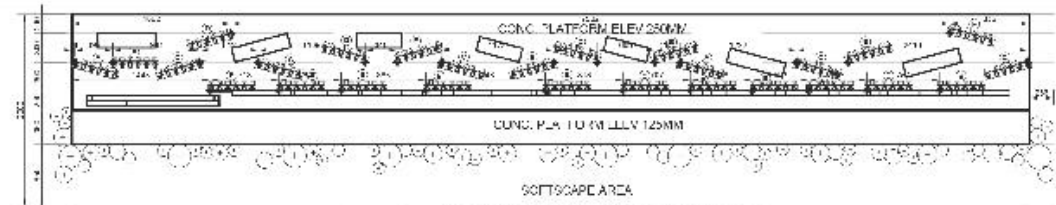

3 TUBULAR SCREEN SETTING LAYOUT  
1:200

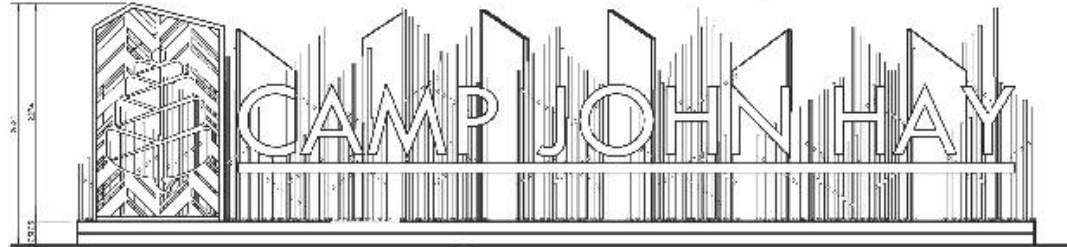

4 FRONT ELEVATION  
1:200

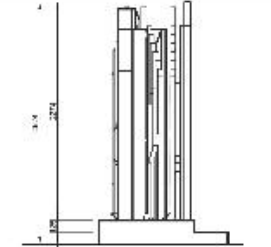

5 LEFT SIDE ELEVATION  
1:200

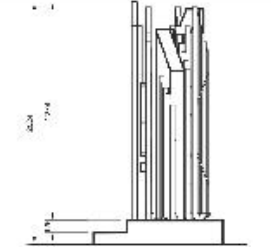

6 RIGHT SIDE ELEVATION  
1:200

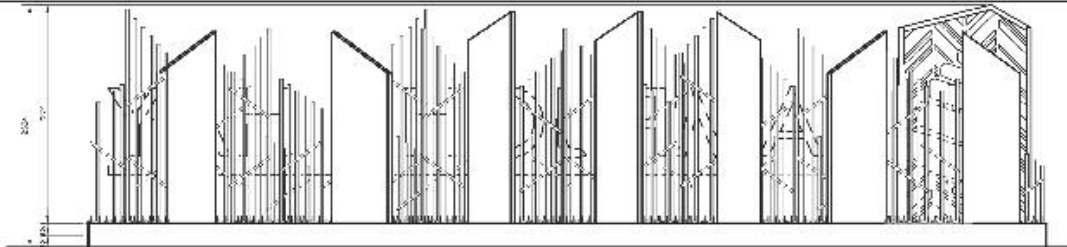

7 REAR ELEVATION  
1:200

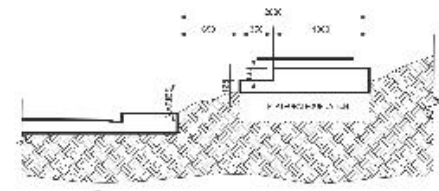

8 PLATFORM SECTION  
1:200

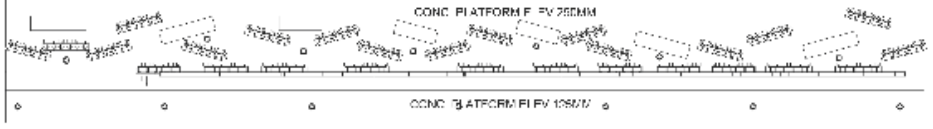

SOFTSCAPE AREA

**1 LIGHTING LAYOUT**  
1/200

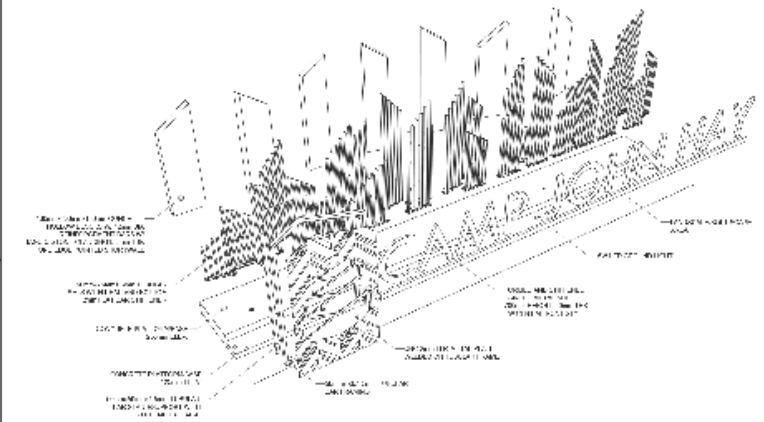

**2 EXPLODED AXONOMETRIC VIEW**  
1/200

**3 SCHEDULE OF COMPONENTS (WALL AND SCREENS)**  
1/200

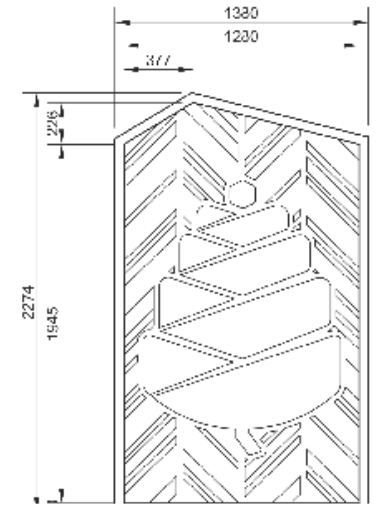
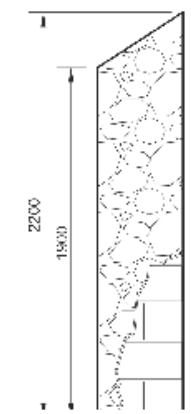
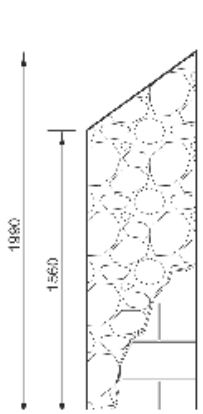
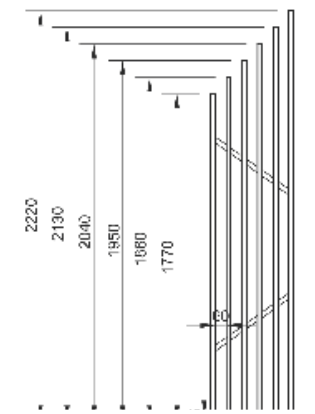
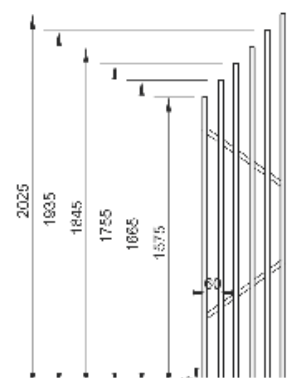
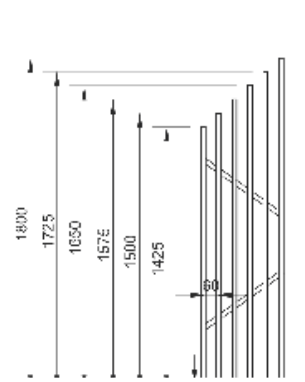
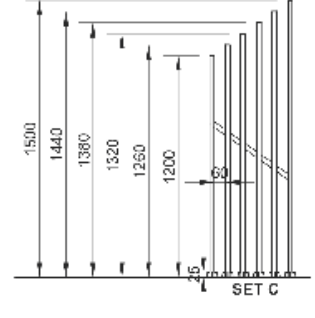
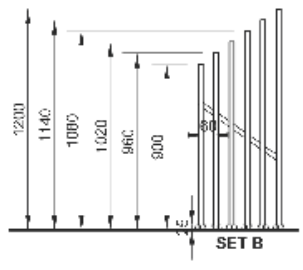
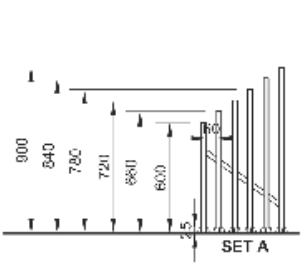



1 PERSPECTIVE  
SCALE 1/8" = 1'-0"  
REV

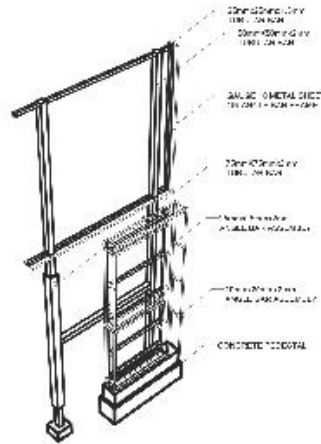

2 FRAMING MODEL  
SCALE 1/4" = 1'-0"  
REV

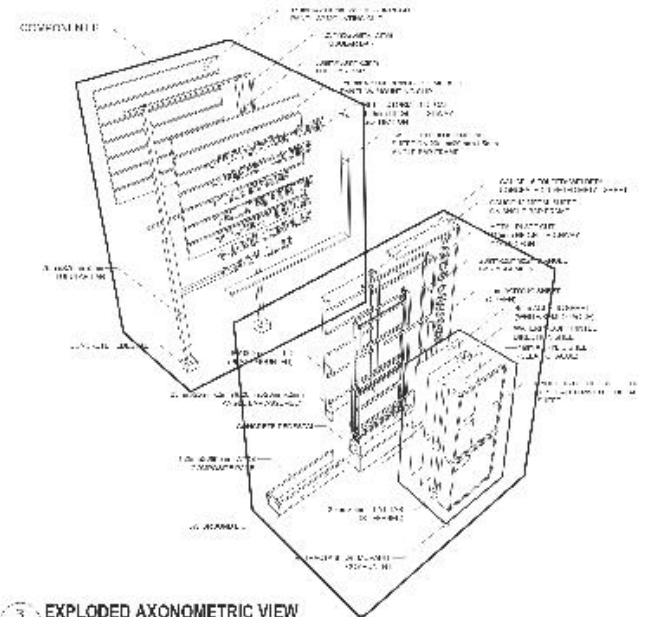

3 EXPLODED AXONOMETRIC VIEW  
SCALE 1/8" = 1'-0"  
REV

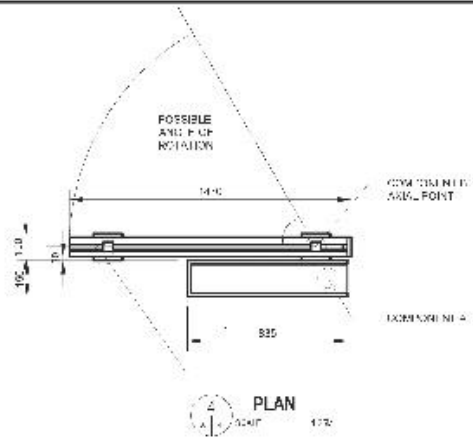

4 PLAN  
SCALE 1/4" = 1'-0"  
REV

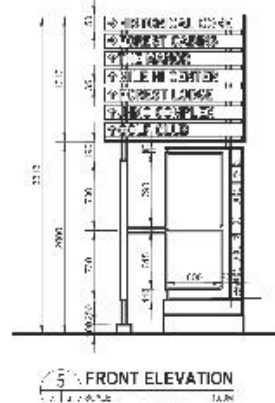

5 FRONT ELEVATION  
SCALE 1/4" = 1'-0"  
REV

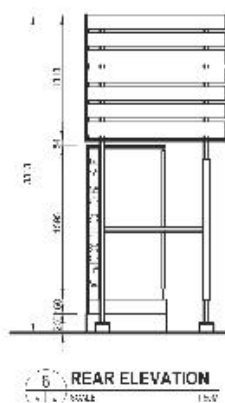

6 REAR ELEVATION  
SCALE 1/4" = 1'-0"  
REV

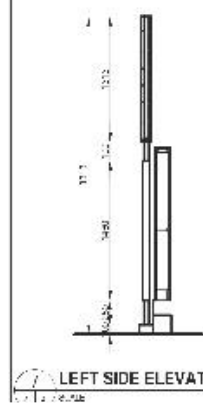

7 LEFT SIDE ELEVATION  
SCALE 1/4" = 1'-0"  
REV

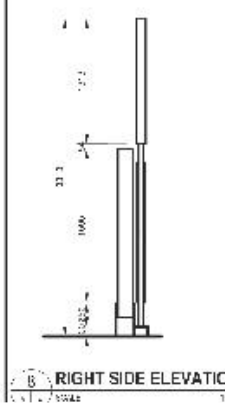

8 RIGHT SIDE ELEVATION  
SCALE 1/4" = 1'-0"  
REV

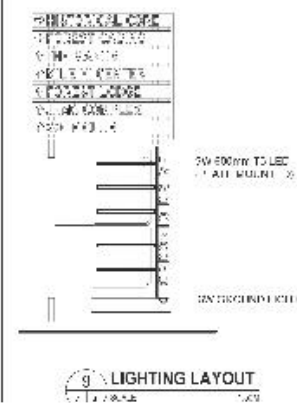

9 LIGHTING LAYOUT  
SCALE 1/4" = 1'-0"  
REV



1 PERSPECTIVE  
SCALE: 1/100  
DATE: 1/12

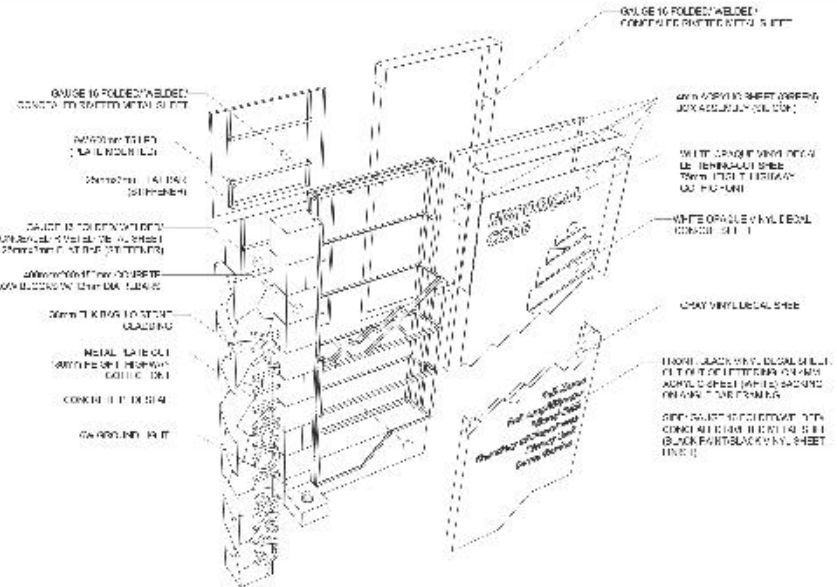

2 EXPLODED AXONOMETRIC VIEW  
SCALE: 1/100  
DATE: 1/12

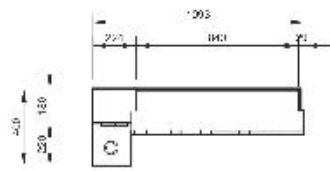

3 PLAN  
SCALE: 1/100  
DATE: 1/12

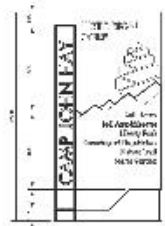

4 FRONT ELEVATION  
SCALE: 1/100  
DATE: 1/12

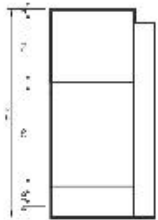

5 REAR ELEVATION  
SCALE: 1/100  
DATE: 1/12



6 LEFT ELEVATION  
SCALE: 1/100  
DATE: 1/12



7 RIGHT ELEVATION  
SCALE: 1/100  
DATE: 1/12

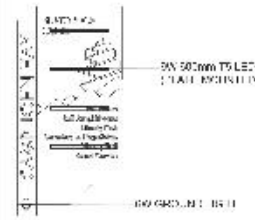

8 LIGHTING LAYOUT  
SCALE: 1/100  
DATE: 1/12

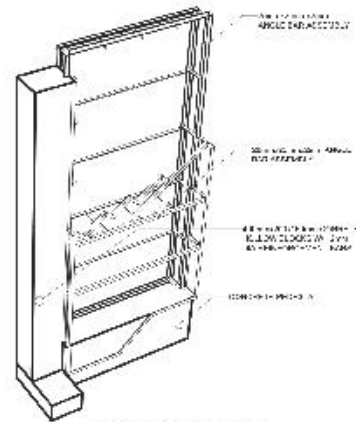

9 FRAMING MODEL  
SCALE: 1/100  
DATE: 1/12



1 PERSPECTIVE  
1/24/17

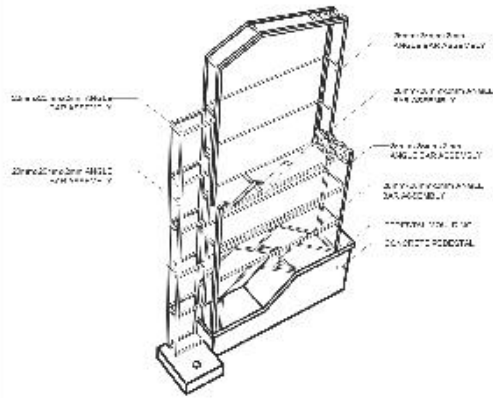

2 FRAMING MODEL  
1/24/17

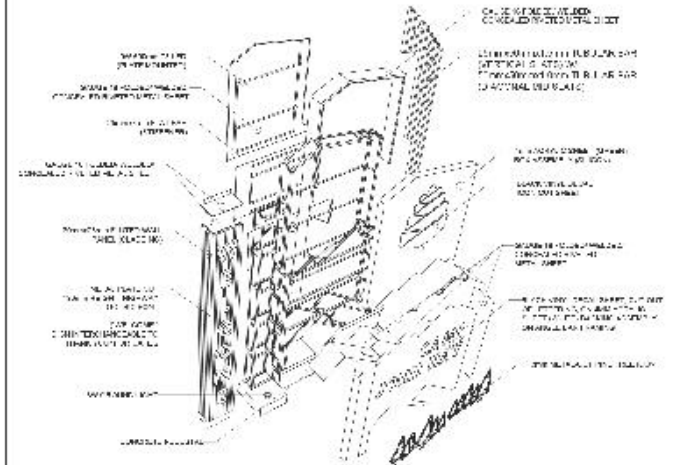

3 EXPLODED AXONOMETRIC VIEW  
1/24/17

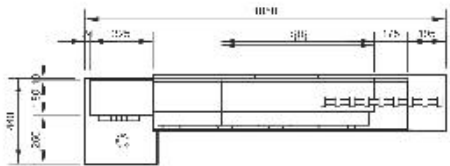

4 PLAN  
1/24/17

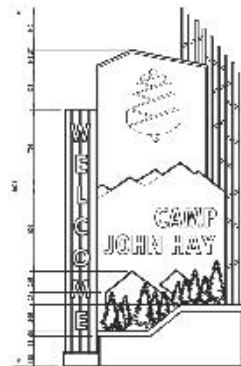

5 FRONT ELEVATION  
1/24/17

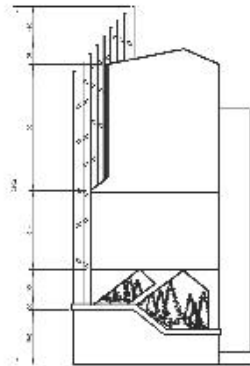

6 REAR ELEVATION  
1/24/17



7 LEFT ELEVATION  
1/24/17

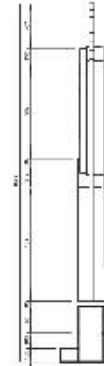

8 RIGHT ELEVATION  
1/24/17

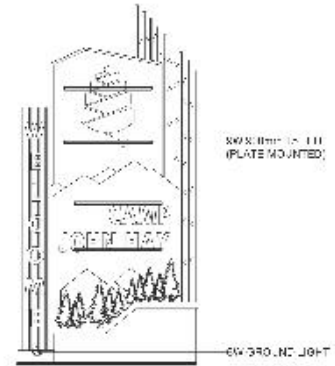

9 LIGHTING LAYOUT  
1/24/17

## *Section VIII. Bill of Quantities*

ANNEX "A"

ITEM NO.	DESCRIPTION	QTY	UNIT	UNIT COST (PhP)	AMOUNT (PhP)

**TOTAL:** \_\_\_\_\_

Name: \_\_\_\_\_

In the capacity of: \_\_\_\_\_

Signed: \_\_\_\_\_

Duly authorized to sign the Bid for and on behalf of: \_\_\_\_\_

Date: \_\_\_\_\_



**GUIDELINES IN PREPARING THE DETAILED UNIT PRICE ANALYSIS (DUPA)**

1. All items of work to be used in preparing the DUPA shall be consistent with the design, plans and specifications prepared by JHMC.
2. For uniformity in the preparation of the Financial Proposal, the DUPA shall be an integral part of the Bidding Documents.
3. All bids shall be composed of the Direct Cost and Indirect Cost.
  - 3.1. **DIRECT COST.**
    - 3.1.1. **MATERIAL COST.** Cost of materials to be used in doing the work item called for, which shall include, among others, the following:
      - 3.1.1.1. Cost at source, including processing, crushing, stockpiling, loading, royalties, local taxes, construction and/or maintenance of haul roads, etc.
      - 3.1.1.2. Expenses for hauling to project site.
      - 3.1.1.3. Handling expenses.
      - 3.1.1.4. Storage expenses.
      - 3.1.1.5. Allowance for waste and/or losses.
    - 3.1.2. **LABOR COST.**
      - 3.1.2.1. Salaries and wages, as authorized by the Department of Labor and Employment.
      - 3.1.2.2. Fringe benefits, such as vacation and sick leaves, benefits under the Workmen's Compensation Act, SSS contributions, allowances, 13th month pay, bonuses, etc.
    - 3.1.3. **EQUIPMENT EXPENSES.**
      - 3.1.3.1. Rental rates of equipment shall be based on the prevailing "Association of Carriers and Equipment Lessors, (ACEL) Inc." approved for use by the DPWH-CAR. Rental rates of equipment not indicated in the ACEL booklet shall be taken from the rental rates used by the proponent. The make, model and capacity of the equipment should be indicated in the detailed unit cost analysis.
      - 3.1.3.2. Mobilization and demobilization shall be treated as a separate pay item. It shall be computed based on the equipment requirements of the project stipulated in the bidder's proposal.
  - 3.2. **INDIRECT COST.**
    - 3.2.1. **Overhead.**
      - 3.2.1.1. Cost to cover power and water consumption and office supplies.
      - 3.2.1.2. Premium on Contractor's All Risk Insurance (CARI).
    - 3.2.2. **Contingencies.** These includes expenses for coordination meetings, ground breaking, inauguration ceremonies and other unforeseen events.
    - 3.2.3. **Miscellaneous Expenses.** Expenses for laboratory tests for quality control.
    - 3.2.4. **Contractor's Profit.**

**Notes:**

1. All sub-items under the General Requirements shall not be subjected to OCM mark-up.
2. The following items under the General Requirements shall not be subjected to Contractor's profit mark-up:
  - a) Mobilization and Demobilization; and
  - b) Permits and clearances

Project Name:

**Fabrication and Installation of  
Signages in the JHSEZ**

Location:

Camp John Hay, Baguio City

## DETAILED UNIT PRICE ANALYSIS

Item No. 1	Description	Quantity	Unit	Unit Price	Amount
1.1	xxxxxx	xx	xx		
Direct Cost: (a+b+c)					
Indirect Cost:					
Contractor's Profit (Except Items 2.1 and 2.6)					
Withholding					
Taxes					
<b>Sub-Total 1:</b> (Sum of Direct and Indirect Cost)					
Item No. 2	Item Description Sub-Item	Unit of Measure:			
2.1	Description	No. of	Daily	No. of	Amount
a.	Labor	Personnel	Rate	Working Days	
	Xxxxxxxx	xx	xxxx.xx	xx	xxxx
					Total Labor Cost: <u>xxxx</u>
b.	Equipment	No. of Unit/s	Daily Rate	No. of Working Days	Amount
	Xxxxxxxx	xx	xxxx.xx	xx	xxxx
					Total Equipment Rentals: <u>xxxx</u>
c.	Materials	Quantity	Unit	Unit Price	Amount
	Xxxxxxxx	xx	xxxx.xx	xx	xxxx
					Total Material Cost: <u>xxxx</u>
Direct Cost: (a+b+c)					
Indirect Cost:					
Overhead					
Contingencies					
Miscellaneous					
Contractor's Profit					
Withholding					
Taxes					
<b>Sub-Total 2.1:</b> (Sum of Direct and Indirect Cost)					

2.2	Sub-Item Description	Unit of Measure:			
a.	Labor	No. of Personnel	Daily Rate	No. of Working Days	Amount
	xxxxxxx	xx	xxxx.xx	xx	<u>xxxx</u>
				Total Labor Cost:	<u>xxxx</u>
b.	Equipment	No. of Unit/s	Daily Rate	No. of Working Days	Amount
	xxxxxxx	xx	xxxx.xx	xx	<u>xxxx</u>
				Total Equipment Rentals:	<u>xxxx</u>
c.	Materials	Quantity	Unit	Unit Price	Amount
	Materials	Quantity	Unit	Unit Price	Amount
	xxxxxxx	xx	xxxx.xx	xx	<u>xxxx</u>
				Total Material Cost:	<u>xxxx</u>
		Direct Cost: (a+b+c)			
		Indirect Cost:			
		Overhead			
		Contingencies			
		Miscellaneous			
		Contractor's Profit			
		Withholding Taxes			
		<b>Sub-Total 2.2:</b> (Sum of Direct and Indirect Cost)			
			Item 2. Total Cost: Item 2. Unit Cost:		

**Project Name:** Fabrication and Installation of Signages  
in the JHSEZ

**Location:** Camp John Hay, Baguio City

DUPA Summary

Item No.	Item Description	Unit	Quantity	Direct Cost				Indirect Cost				Item Cost	Unit Cost	Percent		
				Labor	Equipment	Materials	Total	Overhead	Contingencies	Miscellaneous	Contractor's Profit				Withholding Tax	Total
1	#REF!															
2	General Requirements															
3	xxxxx															
4	xxxxx															
5	xxxxx															
6	xxxxx															
7	xxxxx															
8	xxxxx															
9	xxxxx															
10	xxxxx															
11	xxxxx															
12	xxxxx															

	Amount	Percent
Total Direct Cost:		
a. Labor		
b. Equipment		
c. Materials		
Total Indirect Cost:		
a. Overhead		
b. Contingencies		
c. Miscellaneous		
d. Contractor's Profit		
e. Withholding Taxes		
Total Bid Amount:		

## ***Section IX. Checklist of Technical and Financial Documents***

# Checklist of Technical and Financial Documents

## I. TECHNICAL COMPONENT ENVELOPE

### *Class “A” Documents*

#### Legal Documents

- (a) Valid PhilGEPS Registration Certificate (Platinum Membership) (all pages);  
**or**
- (b) Registration certificate from Securities and Exchange Commission (SEC), Department of Trade and Industry (DTI) for sole proprietorship, or Cooperative Development Authority (CDA) for cooperatives or its equivalent document;  
**and**
- (c) Mayor’s or Business permit issued by the city or municipality where the principal place of business of the prospective bidder is located, or the equivalent document for Exclusive Economic Zones or Areas;  
**and**
- (d) Tax clearance per E.O. No. 398, s. 2005, as finally reviewed and approved by the Bureau of Internal Revenue (BIR).

#### Technical Documents

- (e) Statement of the prospective bidder of all its ongoing government and private contracts, including contracts awarded but not yet started, if any, whether similar or not similar in nature and complexity to the contract to be bid; **and**
- (f) Statement of the bidder’s Single Largest Completed Contract (SLCC) similar to the contract to be bid, except under conditions provided under the rules;  
**and**
- (g) Philippine Contractors Accreditation Board (PCAB) License;  
**or**  
Special PCAB License in case of Joint Ventures;  
**and** registration for the type and cost of the contract to be bid; **and**
- (h) Original copy of Bid Security. If in the form of a Surety Bond, submit also a certification issued by the Insurance Commission;  
**or**  
Original copy of Notarized Bid Securing Declaration; **and**
- (i) Project Requirements, which shall include the following:
  - a. Organizational chart for the contract to be bid;
  - b. List of contractor’s key personnel (*e.g.*, Project Manager, Project Engineers, Materials Engineers, and Foremen), to be assigned to the contract to be bid, with their complete qualification and experience data;
  - c. List of contractor’s major equipment units, which are owned, leased, and/or under purchase agreements, supported by proof of ownership or certification of availability of equipment from the equipment lessor/vendor for the duration of the project, as the case may be; **and**
- (j) Original duly signed Omnibus Sworn Statement (OSS);  
**and** if applicable, Original Notarized Secretary’s Certificate in case of a corporation, partnership, or cooperative; or Original Special Power of

Attorney of all members of the joint venture giving full power and authority to its officer to sign the OSS and do acts to represent the Bidder.

Financial Documents

- (k) The prospective bidder's audited financial statements, showing, among others, the prospective bidder's total and current assets and liabilities, stamped "received" by the BIR or its duly accredited and authorized institutions, for the preceding calendar year which should not be earlier than two (2) years from the date of bid submission; **and**
- (l) The prospective bidder's computation of Net Financial Contracting Capacity (NFCC).

***Class "B" Documents***

- (m) If applicable, duly signed joint venture agreement (JVA) in accordance with RA No. 4566 and its IRR in case the joint venture is already in existence; **or**  
duly notarized statements from all the potential joint venture partners stating that they will enter into and abide by the provisions of the JVA in the instance that the bid is successful.

**II. FINANCIAL COMPONENT ENVELOPE**

- (n) Original of duly signed and accomplished Financial Bid Form; **and**

Other documentary requirements under RA No. 9184

- (o) Original of duly signed Bid Prices in the Bill of Quantities; **and**
- (p) Duly accomplished Detailed Estimates Form, including a summary sheet indicating the unit prices of construction materials, labor rates, and equipment rentals used in coming up with the Bid; **and**
- (q) Cash Flow by Quarter.

Republic of the Philippines



Government Procurement Policy Board